

FORMAT

MUSIC CABINET CO-SPEAKER

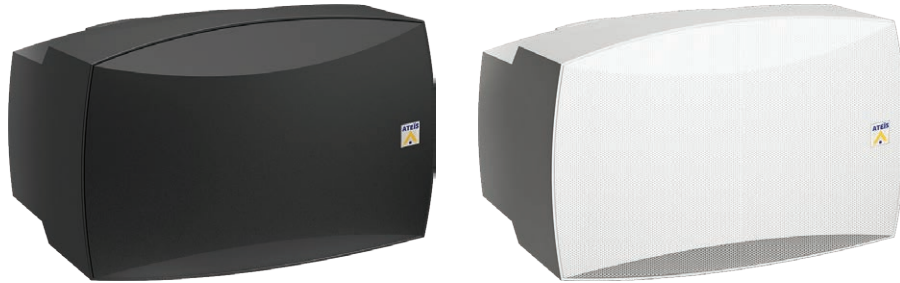

The FORMAT series, FORMAT 20 and FORMAT 40, is designed with very flat frequency response in mind. The coaxial cabinet loudspeaker can reproduce bright midrange, silk-like, high frequencies with an extended Q bass sound.

The FORMAT is designed not only for excellent audio quality in low-Z or 70v/100v line systems, but to sound equally good with streaming audio over IP. The IP version of the FORMAT features an IP amplifier module with 20w/40w output, a high sensitivity microphone, and can be used to stream music as well as intercom over SIP networks. The IP amplifier module can be powered from a PoE/PoE+ network switch or an external AC/DC power adaptor. The module features abundant audio DSP functions to further enhance the sound in the specific environment and functions over SIP AND OnVIF for easy integration with Video CCTV system platforms.

The high sensitivity microphone with the REPIDO™ AEC algorithm and Active Noise Reduction (ANR) enables hands-free long-distance intercom over IP. With the optional RAC 5/8 controller, using the 3 control inputs, users can select various audio sources from the network as well as adjust speaker volume.

With excellent audio quality, voice clarity, and quick and easy installation, FORMAT combines the functions of background music, intercom, and EVAC paging in one speaker. It is suitable for applications including shops, schools, restaurants, hotels, public houses, and offices.

FEATURES

- Supports PoE+ and PoE power
- External power input (24 ~ 27 VDC) if PoE+ or PoE power is not available
- 20W/40W high efficiency Class-D amplifier built-in
- Cost effective and simple installation with single cable deployment
- Easily configured, controlled, managed, and monitored via web browser
- Optional microphone input for hands-free duplex intercom with AEC and Active Noise Reduction (ANR)
- Optional 70V/100V line transformer easily integrate with PAVA system
- Full DSP includes Ducker, AEC, ANR, AGC, PEQ, Hi/Low Pass, Compressor, Limiter, etc.
- IP based for music streaming, routing, paging and control over LAN/WAN
- Supports audio codecs G.711 ulaw, G.711 alaw, G.722, PCM16K, G.726-32, G.727- 32, G.729, MP3
- Internal flash memory (200M) plus microSD card of up to 512 GB available for message or music files storage
- 3rd party control over Ethernet
- 3 control inputs is able to level control and source selection using RAC5/8 and 1 relay contact output



FORMAT

MUSIC CABINET CO-SPEAKER

SYSTEM DIAGRAM

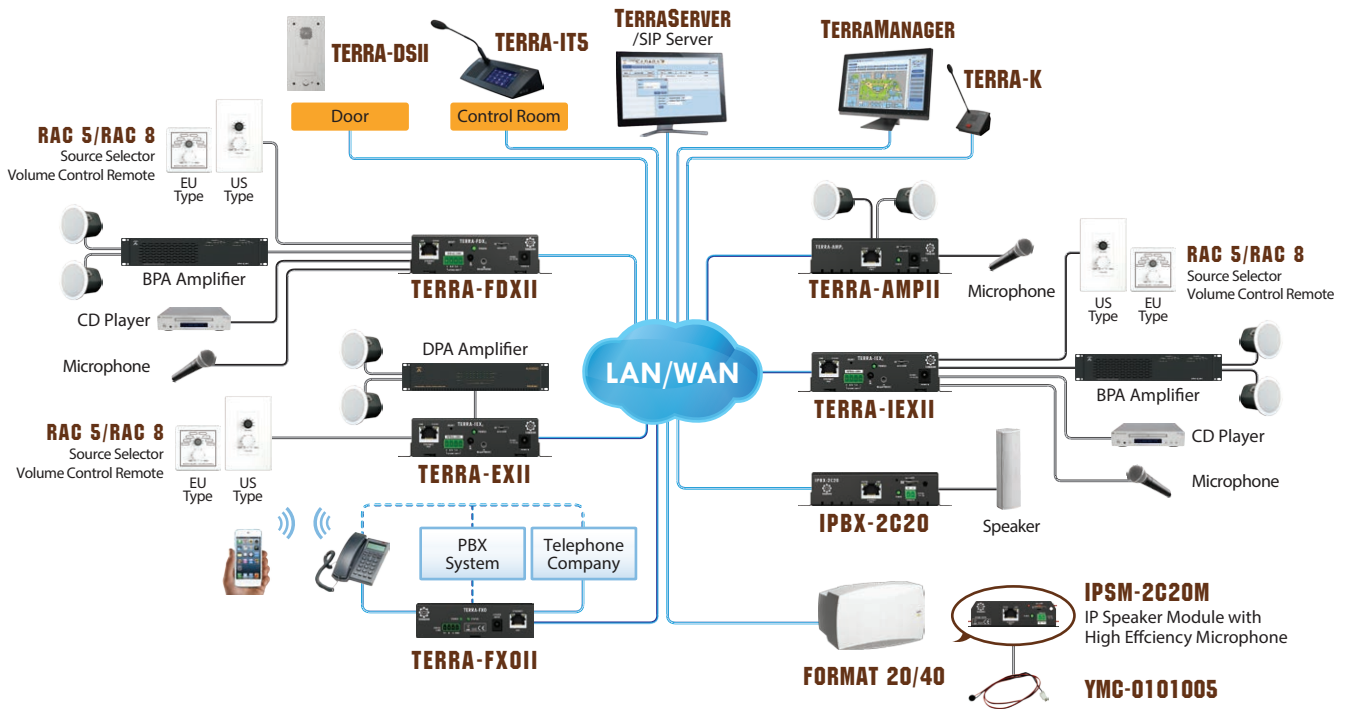

TECHNICAL SPECIFICATIONS

ELECTRICAL

- Rated power
 - FORMAT 20: 20W
 - FORMAT 40: 40W
- Tappings 100 volt line
 - FORMAT 20: 20/10/5/2.5W
 - FORMAT 40: 40/20/10/5W
- Transformer impedance, 100V
 - FORMAT 20: 500/1k/2k/4k ohms
 - FORMAT 40: 250/500/1k/2k ohms
- High/low driver impedance
 - FORMAT 20: 8 ohms
 - FORMAT 40: 7.2 ohms
- Effective frequency range (BSEN60268-5)
 - FORMAT 20: 140 ~ 20k Hz
 - FORMAT 40: 150 ~ 20k Hz
- S.P.L. @ 1m, 1watt, dB, test signal bandwidth 100 Hz - 10k Hz
 - FORMAT 20: 85W
 - FORMAT 40: 87W
- S.P.L. @ 1m, full power, test signal bandwidth 100 Hz - 10k Hz
 - FORMAT 20: 98W
 - FORMAT 40: 103W

MECHANICAL

- Dimensions (W x H x D)
 - FORMAT 20: 265 x 175 x 160 mm
 - FORMAT 40: 365 x 240 x 210 mm
- Weight
 - FORMAT 20: 2.4 kg
 - FORMAT 40: 3.4 kg
- Colour (unless specified): White/Black
- Material: ABS757 molded housing, UV resistant
- Mounting: Die-cast aluminum swivel bracket with PP base

ENVIRONMENTAL

- Min/max amb temp: -25 °C ~ +70 °C (+ 23 °F ~ +122 °F)
- Relative humidity: ≤ 95%

CERTIFICATIONS AND APPROVALS (PENDING)

Europe	CE/EMI	EN 55032
Europe	CE/EMC	EN 61000-3-2 EN 61000-3-3 EN 55035
Europe	CE/LVD	EN 62368-1



ATEIS Europe B.V.

Celsiusstraat 1 - 2652 XN Lansingerland (Rotterdam Region), Netherlands

Tel: +31 (0)10 2088690 | www.ateis-europe.com | info@ateis-europe.com





FORMAT

MUSIC CABINET CO-SPEAKER

TOP PANEL

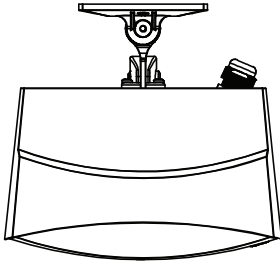

SIDE VIEW
FORMAT 20

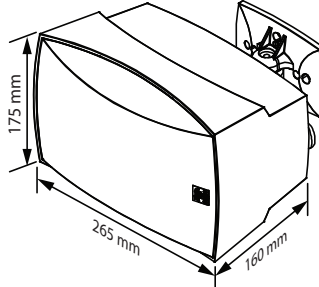

WITH TRANSFORMER

70V LINE

FORMAT 20				
70V	10W	5W	2.5W	1.25W
IMP.(Ω)	500	1K	2K	4K
FORMAT 40				
70V	20W	10W	5W	2.5W
IMP.(Ω)	250	500	1K	2K

100V LINE

FORMAT 20				
100V	20W	10W	5W	2.5W
IMP.(Ω)	500	1K	2K	4K
FORMAT 40				
100V	40W	20W	10W	5W
IMP.(Ω)	250	500	1K	2K

FRONT PANEL

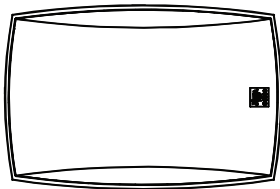

FORMAT 40

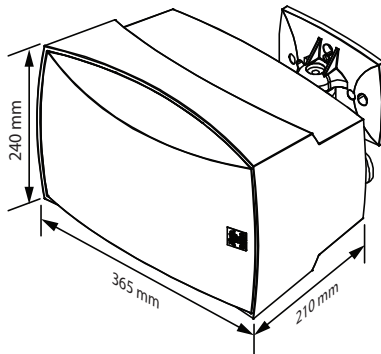

MOUNTING BRACKET

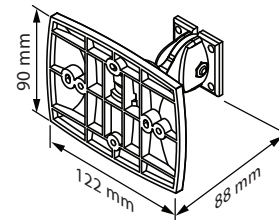

FREQUENCY RESPONSE

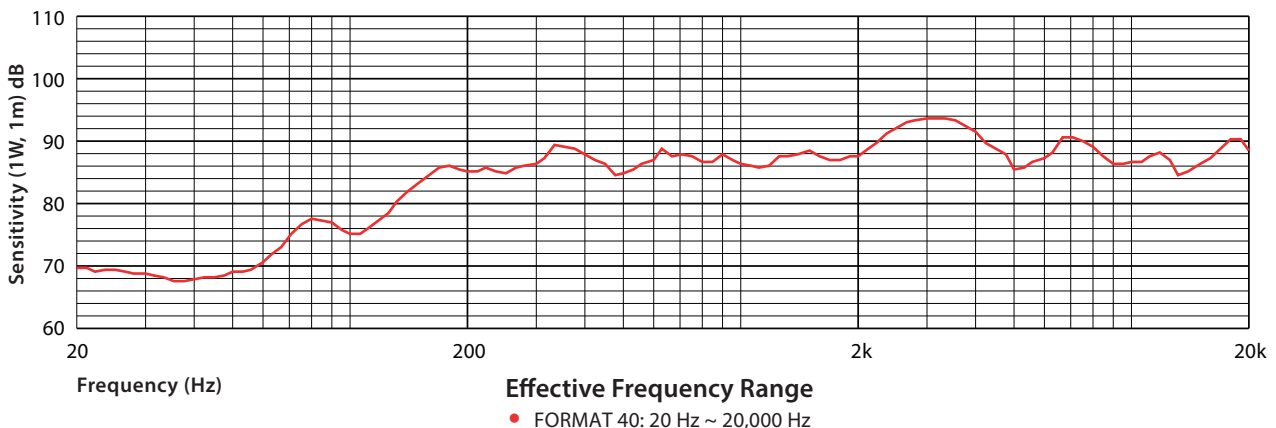
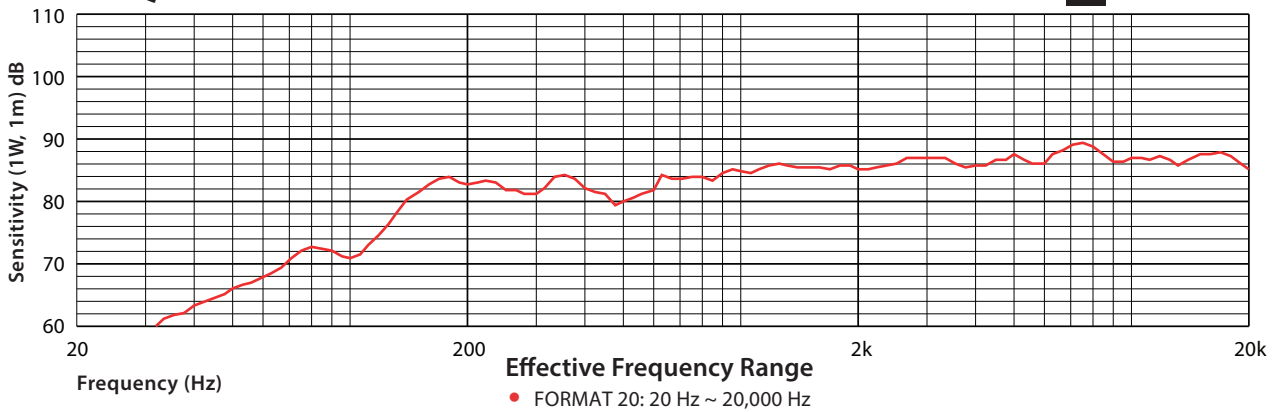

Disclaimer: We reserve the right of changes and errors.



ATEIS Europe B.V.

Celsiusstraat 1 - 2652 XN Lansingerland (Rotterdam Region), Netherlands

Tel: +31 (0)10 2088690 | www.ateis-europe.com | info@ateis-europe.com



FORMAT

MUSIC CABINET CO-SPEAKER

ORDERING INFORMATION

Model No.	Step 1	Step 2	Step 3	Step 4	Step 5	Description of Model
FORMAT	Driver Handling	Line Transformer	Colour	- IP Speaker Module	Microphone	Music Cabinet Co-Speaker
Driver Handling						
	20					Driver Handling 20W
	40					Driver Handling 40W
Line Transformer						
						IP Speaker Module Only
		L				Low Impedance Only
		/T				100V Line
		/T7				70V Line
Colour						
			B			Black
			W			White
IP Speaker Module						
						None
				IP		IP Speaker Module
Microphone						
						None
					M	Mic Input Module & Capsule

